

• Motorized unit

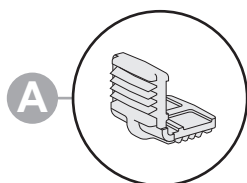

A corner key

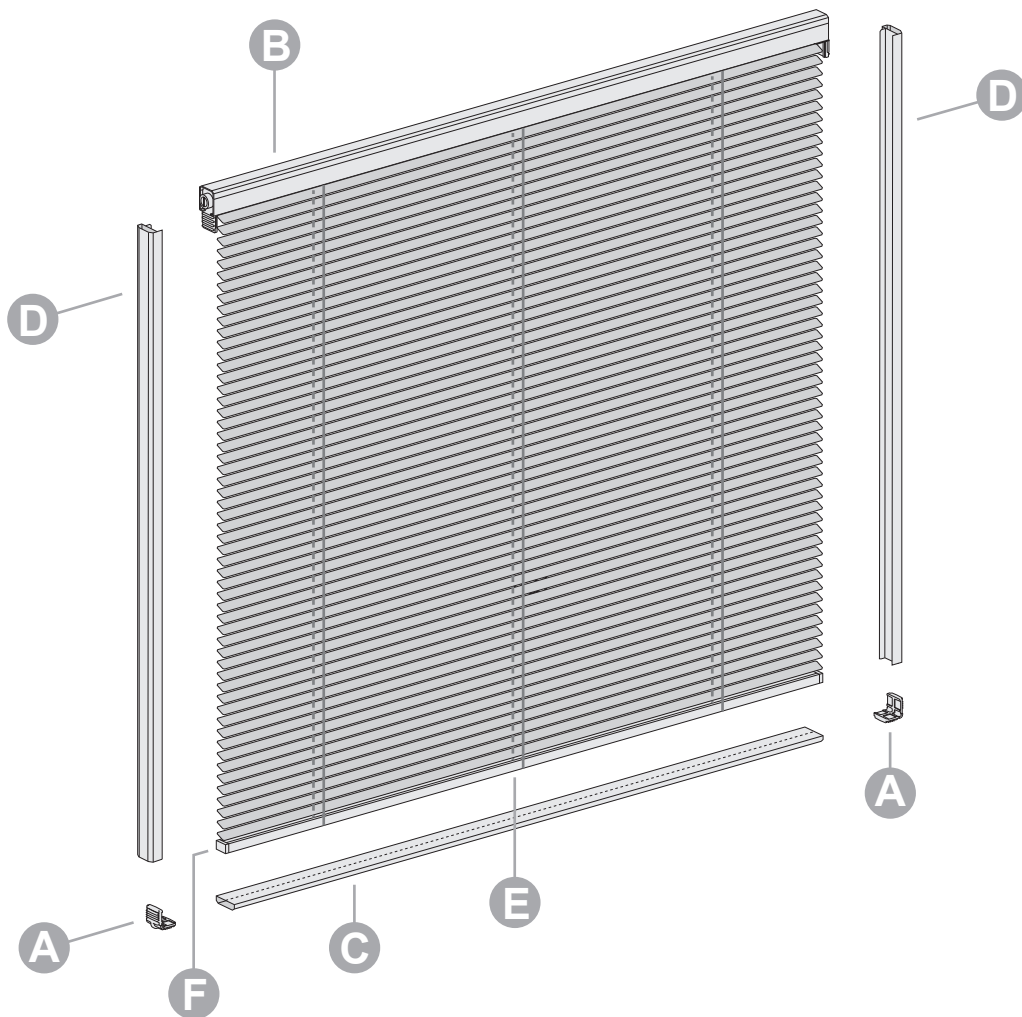
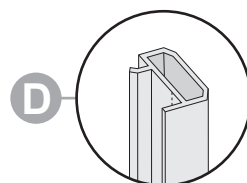

D side spacer

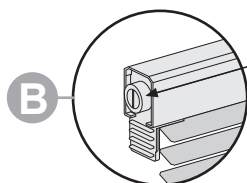

power + control
motor socket
B head rail

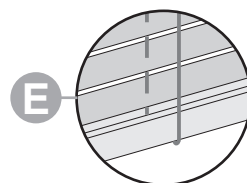

E blind field

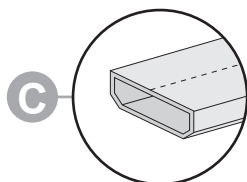

C bottom spacer

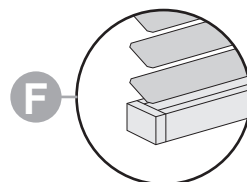

F bottom rail

Exploded view of a betweenglassblind tilt and lift unit

