



betweenglassblinds™

INSTALLATION AND USE

HARDWIRED BLINDS WITH CONTROL UNIT

Video instructions

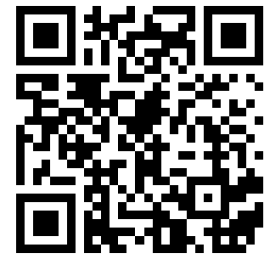

ELECTRICAL WIRING DIAGRAM

GENERAL SWITCH

Allows to raise or lower all the blinds simultaneously.

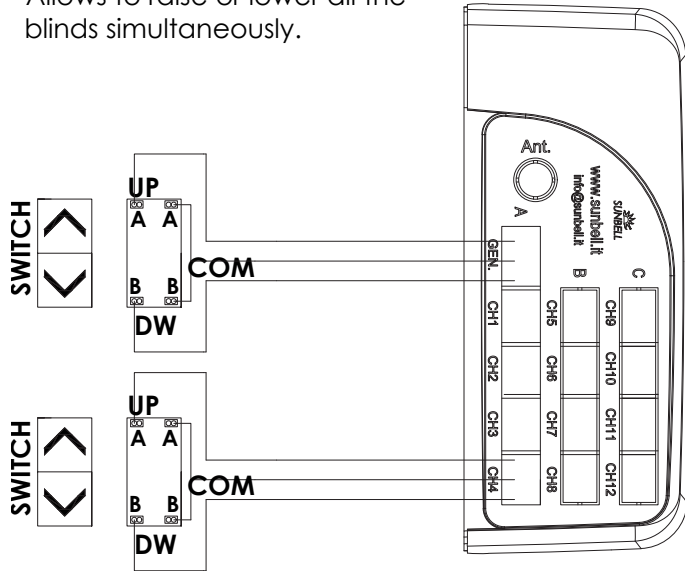

SINGLE SWITCH

Allows to raise and lower one blind.

WARNING!
IN CASE OF CONNECTION TO **HOME AUTOMATION SYSTEMS**, THE CONTROLLERS HAVE TO **SIMULATE** THE FUNCTIONING OF THE **TRADITIONAL WALL SWITCHES!**

WARNING!
DO NOT CONNECT MORE THAN 1 BLIND TO 1 OUTGOING CHANNEL!
IN ORDER TO **OPERATE MORE THAN 1 BLIND** WITH A SINGLE SWITCH, CONNECT 2 **INGOING** CHANNELS IN PARALLEL WITH THE SWITCH.

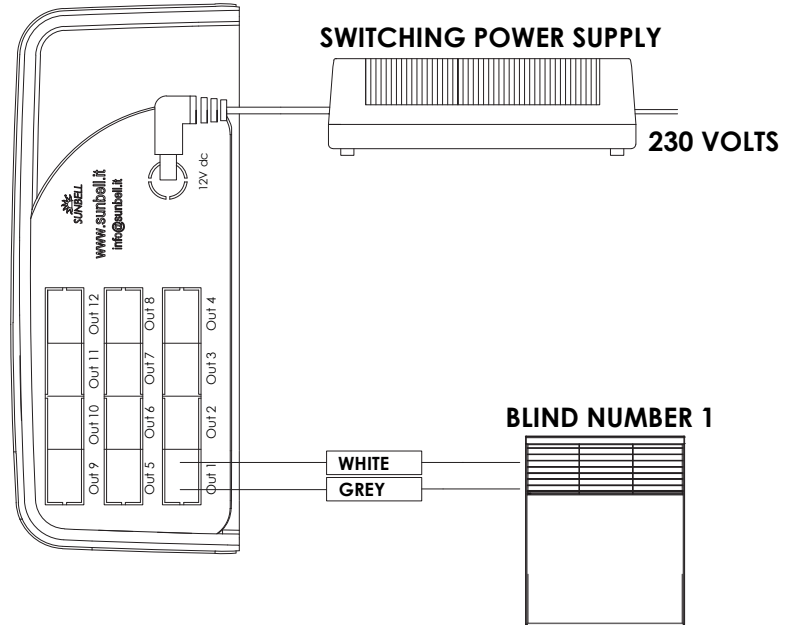

SIZE, DIMENSIONS AND MAXIMUM DISTANCES

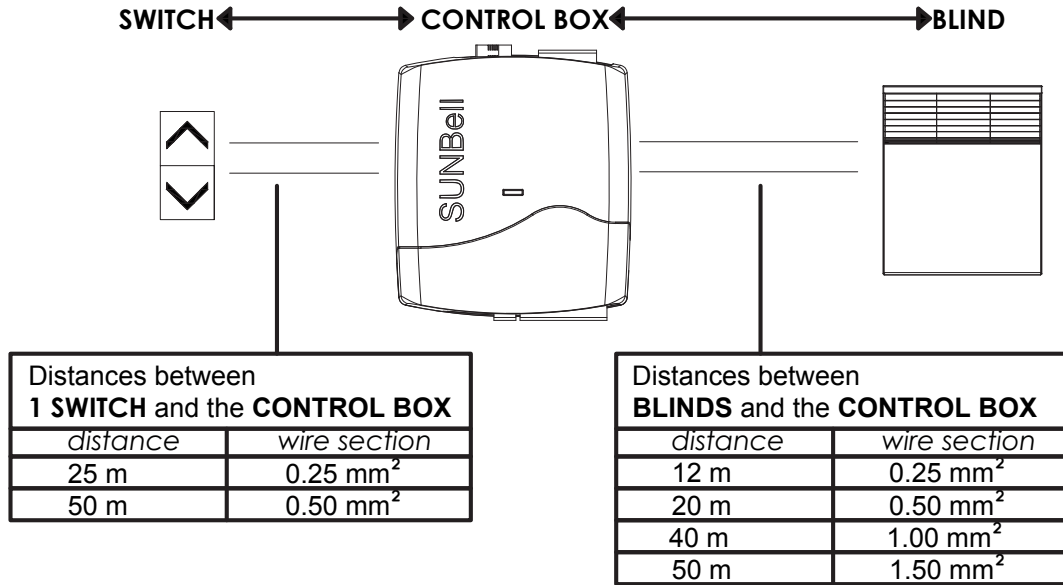

N.B.: STANDARD CABLE LENGTH 2000 mm

CONTROL BOX DIMENSIONS

132mmx115mmx49mm

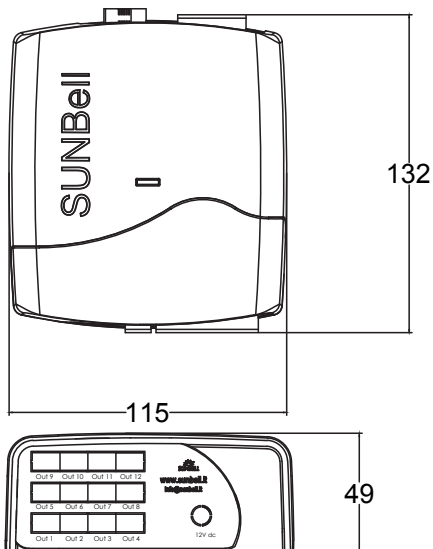

POWER SUPPLY DIMENSIONS

L 156 mm x P 68 mm x H 40 mm (10-12 channels)

L 128 mm x P 52 mm x H 32 mm (6-8 channels)

L 108 mm x P 47 mm x H 29 mm (4 channels)

L 96 mm x P 45 mm x H 31 mm (2 channels)

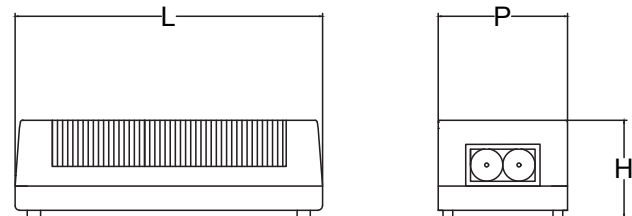

ELECTRICAL CONTACT CONNECTORS

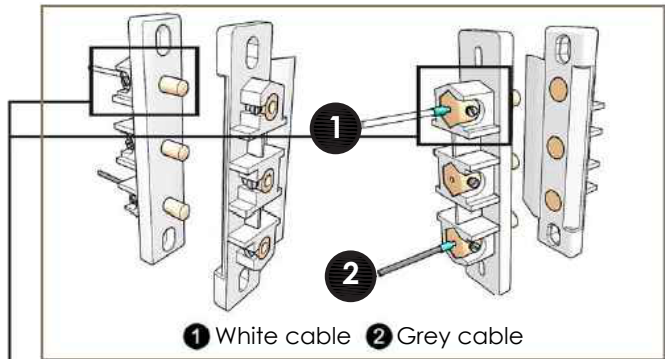

WARNING: do not tamper or modify the plastic wings. **Danger of short circuit!**

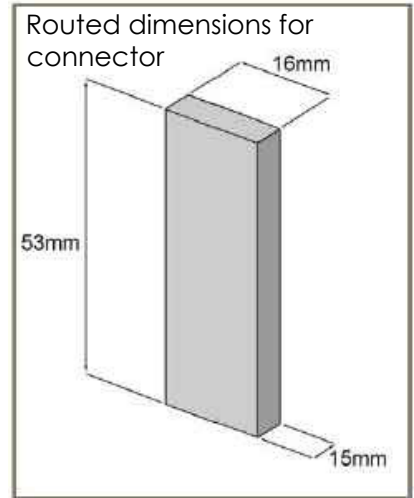

FIXING CABLES TO CONNECTOR

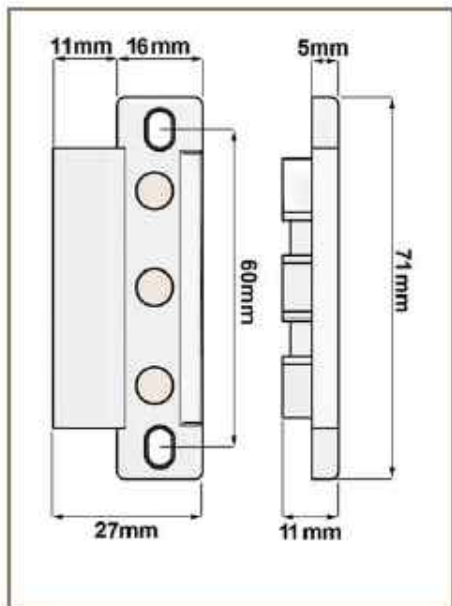

Located on the frame

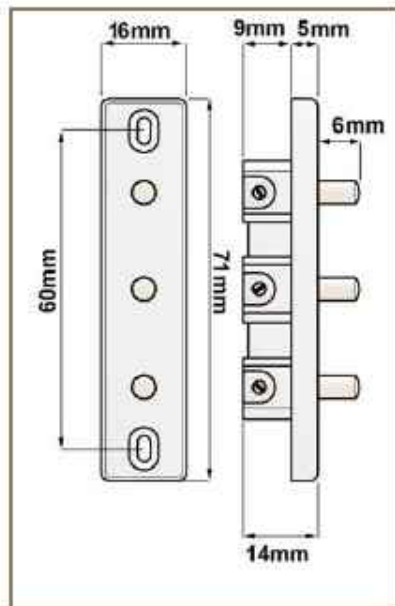



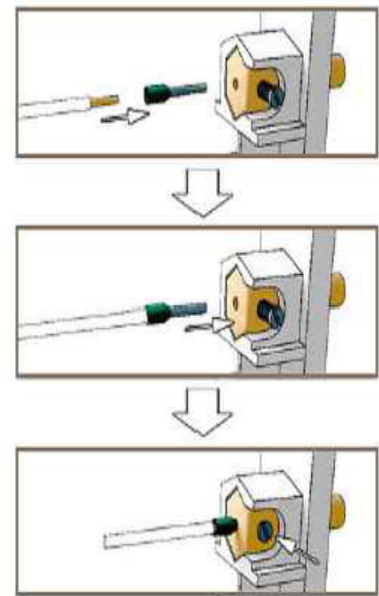



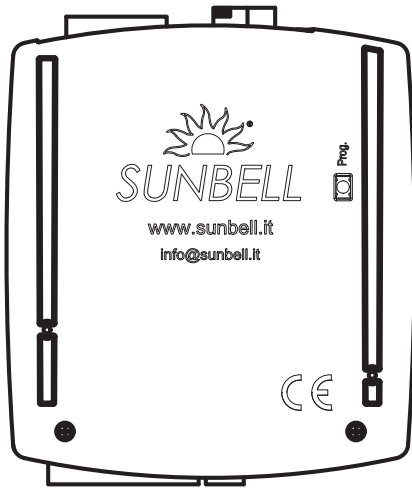

Located on the hinged side



REMOTE CONTROL CONFIGURATION



- Press the "Prog" button on the back of "SUNCEN" control box.
- Within 30 seconds, turn the remote control on (keeping the  button pressed), select one of the channels (buttons   ) and press  or .
- Wait 5 seconds then press  or  one more time.
- The raising/lowering of the corresponding blind confirms the correct and complete configuration.

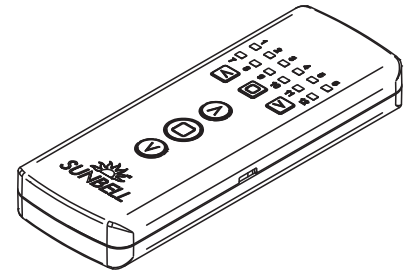



In case of multiple control boxes in the same building it is possible to vary the frequency as shown in the remote control user's manual.

USING THE REMOTE CONTROL

Power

Keep the  button pressed for 1 second. The white LEDs corresponding to the selected blinds turn on (the last selection made is saved).

Blinds selection

Select the blinds by using the buttons   . The flashing of the white LED indicates the current blind.

Press the  button to select the blind: a slower flashing of the white LED indicates that the selection is made.





The white LEDs steadily lit indicate the selected blinds. So it's possible to raise or lower single blinds, a group of blinds or all the blinds simultaneously.

Simultaneously press (for 1 second) the  and  buttons to select or deselect all the 12 blinds.

Raising, lowering and tilting the blinds

Press  or  button to raise or lower the blinds.

To change direction of the blinds' movement stop it by pressing the  button, then press  or  button.

Keep  or  button pressed to raise or lower the blinds in slow mode. Keep  or  button pressed to tilt the slats (function not available with fabric blinds).

The blue flashing of the LED indicates the transmission of the command.

Stop the blinds

Press the  button to stop the moving blinds. The blue LED flashing indicates the transmission of the command.

Stand by

The remote control automatically turns off after a 20 seconds inactivity. Every LED turns off.

USING THE WALL SWITCH

SINGLE SWITCH MOVEMENT

- The single pressure of the button (UP or DOWN direction, less than 1 second) allows to raise or lower the blind in fast function. The blind will stop when totally raised or lowered, or by pressing the button once more.
- The continuous pressure of the button (more than 1 second), allows to raise or lower the blind in slow function. It is possible to tilt the slats by keeping the opposite direction button pressed.

Important! In order to transmit a new command to the control box during fast function it is necessary to interrupt the previous one by pressing the UP or DOWN button once.

GENERAL SWITCH MOVEMENT

The general switch works exactly like the single switches, allowing to move every blind.

Warning! Use interlocked, 2 positions switches ONLY.

HOME AUTOMATION SYSTEMS - GUIDELINES

- Blinds must be connected to SUNBELL control box and switching power supply only.
- Blinds cannot be directly powered by the controllers of the home automation system.
- Controllers have to simulate the functioning of the traditional wall switches.
- Controllers have to produce the same pressing time of the traditional wall switches.
- CONTROLLERS CLOSING TIMES:
 - from 0.2 to 1.0 second: automatic fast function (raising and lowering function);
 - over 1.0 second: manual slow function (tilting function).



WARNING!

Using components not provided by Sunbell or not in conformity with the technical specifications provided, not respecting the instructions of use and installation will result in a void of warranty.



51-55 FOWLER ROAD • HAINAULT BUSINESS PARK
HAINAULT • ESSEX IG6 3XE

TEL: 020 8500 2200 • FAX: 020 8559 8584
sales@betweenglassblinds.co.uk

www.betweenglassblinds.co.uk